



USER'S MANUAL

CONTENTS

1. GUIDE	2
1.1 IMPORTANT SAFETY INSTRUCTIONS	2
1.2 UNPACKING	2
1.3 PRODUCT OVERVIEW& ILLUSTRATION	3
1.4 INSTALLATION OF METER	4
2. OUTLINE	5
3. THE MENU OSD INSTRUCTION	6
3.1 SATELLITE	6
3.2 DVB-T/T2	8
3.3 DVB-C	10
3.4 SPECTRUM	11
3.5 NETWORK	12
3.6 OTHERS	13
3.7 SYSTEM SETTING	18
4. TECHNICAL SPECIFICATION	21
5. TROUBLE SHOOTING	23

1. GUIDE

1.1 IMPORTANT SAFETY INSTRUCTIONS

Thank you for choosing our product. Before installation, we would like to remind you some notes, which is very important for operating safely and properly, as follows:

- Be sure to read this user manual before starting your operation.
- You must install the dish with correct direction and angle. If the dish is not working properly, contact your local dealer.
- When the unit is suddenly moved to a hot area from a cold area, it may cause some problems. In that case, turn off the power, and turn on again after 1-2 hours.
- Keep meter placed in clean space with sufficient ventilation.
- Do not cover the meter with or place it on a unit that emits heat.
- Clean the case by a soft cloth with a little washing liquid.
- Do not remove the cover.
- Do not let the unit exposed to extreme heat, cold or humid conditions.
- No liquids or any other materials to come inside of the unit.

1.2 UNPACKING

Open the package and make sure it includes all below items, if any missing, please contact the reseller for replacement.

- | | |
|----------------------------|------------------|
| 1. Digital Satellite Meter | 8. BNC-Connector |
| 2. User's manual | 9. RF connector |
| 3. AV cable | |
| 4. Car charger cable | |
| 5. Power adaptor | |
| 6. Carrying bag | |
| 7. DC 12V connect line | |

NOTE: Please refer to our actual configuration.

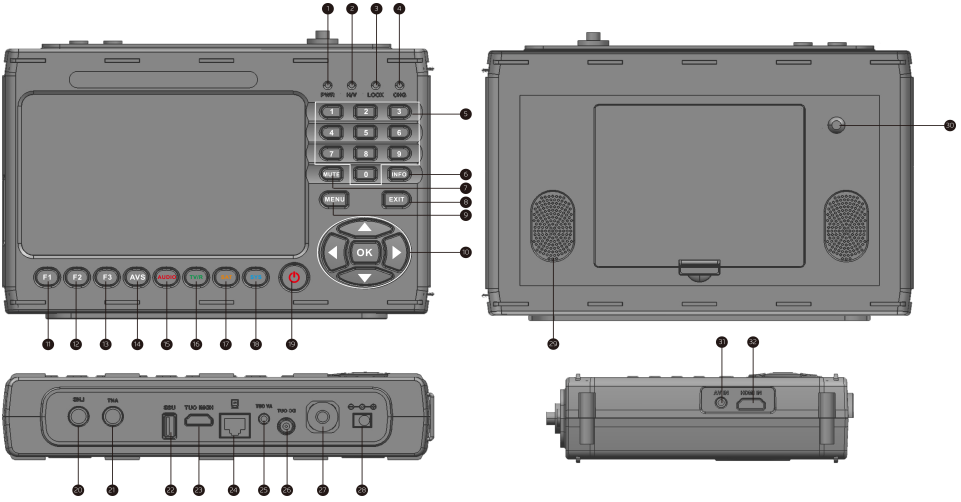

1.3 PRODUCT OVERVIEW& ILLUSTRATION

NO	Description	FUNCTION
1	Power	Power indicator light
2	H/V	Vertical /Horizontal polarization voltage output light
3	LOCK	Signal lock indicator light
4	CHG	Charger indicator light
5	0-9	Number key to select channels or enter programming
6	INFO	INFO key
7	MUTE	MUTE
8	EXIT	Escape from present menu and save the settings
9	MENU	Show the main menu on the screen or jump back to previous menu in sub-menu setting conditions
10	NEVIGATION KEY	Volume Control or move cursor, channel or change, confirm etc
11	F1	Auxiliary function key
12	F2	Auxiliary function key
13	F3	Auxiliary function key
14	AVS	Signal source switch key
15	Red & AUDIO	Red KEY & Audio setting
16	Green & TV/R	Green key & TV and radio switch
17	Yellow & SAT	Yellow key & Shortcut key for Satellite

NO	Description	FUNCTION
18	BLUE & SYS	Blue key & Shortcut key for System setting
19	Power Switch	Turn on/off meter
20	LNB In	Connect to satellite cable
21	ANT IN	Connect to antenna
22	USB	USB port for software upgrading or multimedia playing
23	HDMI OUT	HDMI output port
24	LAN	Ethernet connection port
25	AV OUT	Audio/Video output port
26	DC OUT	DC 12V output for extern equipment
27	Optical fiber port	Connect optical device
28	DC IN	Connect to power adaptor
29	Speaker	Speaker integrated
30	Torch LED	Night lighting
31	AV IN	Audio/Video input port
32	HDMI IN	HDMI input port

1.4 INSTALLATION OF METER

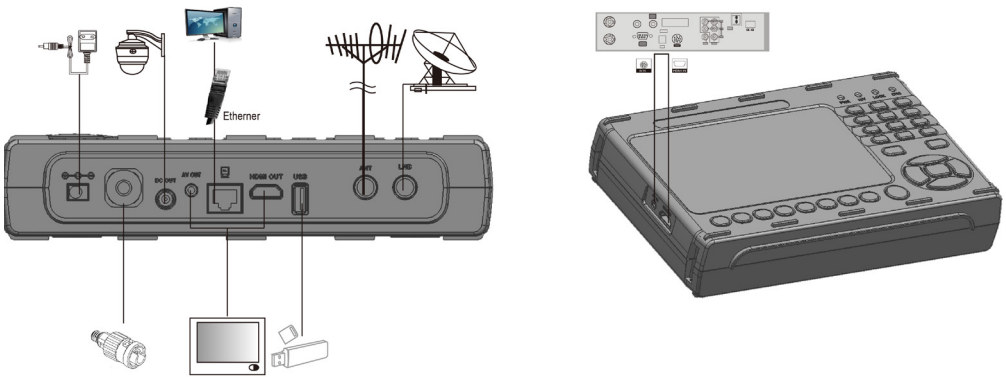

2. OUTLINE

- 7 Inch High Definition TFT LCD Screen
- Fully DVB-S/S2/T/T2/C, MPEG-2/MPEG-4 compliant
- MPEG-2 / H.264 / H.265(10 Bit)Hardware decoding
- Digital meter for signal strength and quality
- Constellation analyzer
- Spectrum analyzer
- Supports scan of Auto,Blind, Manual or NIT
- Sound and Light Alarm for Locking Signal
- Auto Calculate Angle of AZ ,EL
- Supports DISEQC 1.0/1.1/1.2, Unicable, 0/22kHz Tone
- Speaker Integrated
- Support both AV out and AV in
- Support both HDMI out and HDMI in
- Support WiFi and Ethernet connection
- Optical Power measurement
- LNB short protect
- 7.4V/5000mAh Li-Ion Battery Included
- Software upgrade via USB port
- Easy to carry

3. THE MENU OSD INSTRUCTION

If you have installed and connected the cables to the product, pressing **MENU** to display the Main Menu.

- Satellite
- Terrestrial
- Cable
- Spectrum
- Network
- Others
- Media Center
- Setting

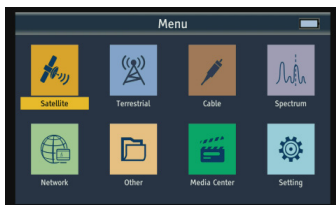

Press the keys of **▲▼◀▶** to move the cursor up or down in the menu interface, then use **OK** to confirm the selection.

3.1 SATELLITE

Select Satellite, then press **OK** into the Satellite Setup.



3.1.1 SATELLITE

Press **OK** into the satellite list. Use **▲▼** key to move the cursor, then press **OK** to select the satellite you want.



3.1.2 LNB FREQ

Press **OK** into the LNB Frequency list. Use **▲▼** key to move the cursor, then press **OK** to select the LNB Frequency you want.



3.1.3 TRANSPONDER

Press **OK** into the TP list. Use **▲▼** key to move the cursor then press **OK** to select the TP you want.



3.1.4 FREQUENCY

Frequency of the current transponder, input value by using the number keys.

3.1.5 SYMBOL RATE

Symbol rate of the current transponder, input the value by using the number keys.

3.1.6 POLARITY

Press **◀▶** key to change vertical or horizontal of polarization.

3.1.7 22KHZ

Press **◀▶** key to turn on or off 22kHz TONE Switch.

3.1.8 DISEQC 1.0

Press **◀▶** key to set the DiSeqC 1.0 port range from port 1 to port 4.

3.1.9 DISEQC 1.1

Press **◀▶** key to set the DiSeqC 1.0 port range from port 1 to port 16.

3.1.10 LNB POWER

Press **◀▶** key to Switch LNB Power ON/OFF.

3.1.11 QUICK SEARCH

When parameters have been set done, press **OK** into Satellite quick search. There will have some signal information displayed on the screen.

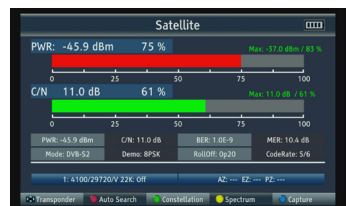

- TP Search: Press **OK** to search the current TP.

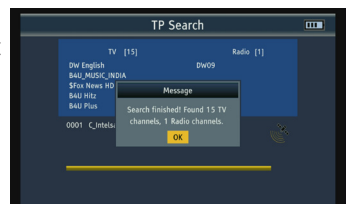

- Auto Search: Press the red key to automatically search for the current satellite.



- Constellation: Press the green key into the constellation.

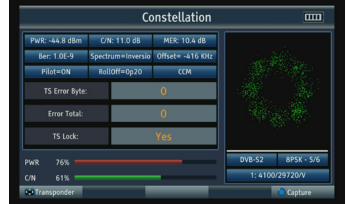

- Spectrum: Press the yellow key into the Satellite Spectrum. Please refer to **3.4.1 Spectrum_S2** for detail.
- Capture: Press the blue key to capture the current picture.

3.2 DVB-T/T2

Select Terrestrial, then press **OK** into the terrestrial Setup.



3.2.1 COUNTRY

Press **OK** into the country list. Use **▲▼** key to move the cursor, then press **OK** to select the country you want.

3.2.2 CHANNEL

Press **OK** into the channel list. Use **▲▼** key to move the cursor, then press **OK** to select the channel you want.

3.2.3 FREQUENCY

Frequency of the current channel, input value by using the number keys .

3.2.4 BANDWIDTH

Press ◀▶ key to change the bandwidth, we can select 5, 6, 7 or 8M.

3.2.5 LCN

Press ◀▶ key to switch LCN ON/OFF.

3.2.6 ANTENNA POWER

Press ◀▶ key to change the antenna power, there are 3 types including 5V/12V/24V.

3.2.7 ANTENNA SETUP

Press ◀▶ key to switch antenna power ON/OFF.

3.2.8 QUICK SEARCH

When parameters have been set done, press **OK** into quick search. There will have some signal information displayed on the screen.



- TP Search: Press **OK** to search the current TP.

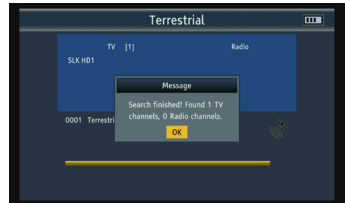

- Auto Search: Press the red key to automatically search for the current country channels.



- Constellation: Press the green key into the constellation.



- Spectrum: Press the yellow key into the Terrestrial Spectrum. Please refer to

3.4.1 Spectrum_T2 for detail.

- Capture: Press the blue key to capture the current picture.

3.3 DVB-C

Select Cable, then press **OK** into the Cable Setup.



3.3.1 COUNTRY

Press **OK** into the country list. Use **▲▼** key to move the cursor, then press **OK** to select the country you want.

3.3.2 CHANNEL

Press **OK** into the channel list. Use **▲▼** key to move the cursor, then press **OK** to select the channel you want.

3.3.3 FREQUENCY

Frequency of the current channel, input value by using the number keys.

3.3.4 SYMBOL RATE

Input symbol rate by using the number keys.

3.3.5 MODULATION

Press **◀▶** key to switch modulation mode, and QPSK/QAM16/QAM32/QAM64/QAM128/QAM256 optional.

3.3.6 ANTENNA POWER

Press **◀▶** key to change the antenna power, there are 3 types including 5V/12V/24V.

3.3.7 ANTENNA SETUP

Press **◀▶** key to switch antenna power ON/OFF.

3.3.8 QUICK SEARCH

Please refer to **3.2.8**.

3.4 SPECTRUM

- Spectrum_S2
- Spectrum_T2
- Spectrum_C



3.4.1 SPECTRUM_S2

Press ◀▶ key to change Frequency;
 Press the red key to change span including 240MHz/640MHz/Full;
 Press the green key to change vertical or horizontal of polarization;
 Press the yellow key to switch 22K on or off;
 Press the blue key to capture the current picture.

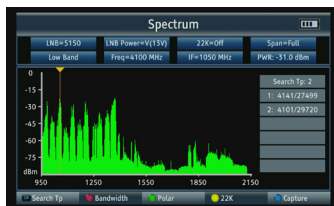

3.4.2 SPECTRUM_T2

Press ◀▶ key to change Frequency;
 Press the red key to change span including Full/Channel;
 Press the green key to enlarge showing the point you selected, and press again it will be back.
 Press the yellow key scan the current channel.
 Press the blue key to capture the current picture.

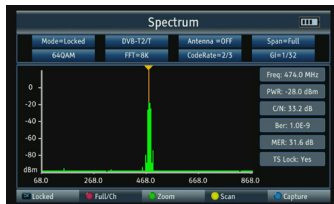

3.4.3 SPECTRUM_C

Please refer to **3.4.2**.

3.5 NETWORK

- WiFi
- Ethernet
- Youtube



3.5.1 WIFI

- Link Type: The current link type is WiFi.
- WiFi Manager: Press **OK** to enter WiFi Manager interface, and it will display the WiFi device list which you can select one to connect you want.
- Config Mode: Support DHCP mode and Static IP mode.
- IP Address: Input IP address by using number keys in Static IP mode.
- Netmask: Input Netmask address address by using number keys in Static IP mode.
- Gateway: Input Gateway address by using number keys in Static IP mode.
- DNS Server: Input DNS Server address by using number keys in Static IP mode.
- Mac Address: Local Mac address.
- Ping Test: Test network through ping IP address.



1、 URL Type

Press ◀▶ key to change URL Type, and Number type and String type optional;

2、 IP Address

Input IP address or domain name by using number keys.

3、 Times

Repeat times of the Ping test.

4、 Start

Start testing button.

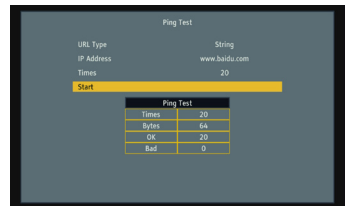

- Connect: WiFi connection button.

3.5.2 ETHERNET

Please refer to **3.5.1**.



3.5.3 YOUTUBE

Built in YouTube application.



3.6 OTHERS

- TV Channel List
- Radio Channel List
- Satellite List
- Transponder List
- Motor Setup
- Scan Mode
- Loop Search
- Angle Calculation
- Optical Power

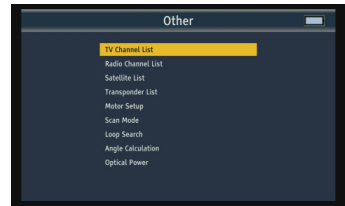

3.6.1 TV CHANNEL LIST

To show TV channel list and channel information.



- Group

Press the F1 key to switch different group of the channel list.

- Lock

Press the red key to enter lock status, then press **OK** to mark channel you

want to lock it.

- Skip

Press the green key to enter skip status, then press **OK** to mark channel you want to skip it.

- Move

Press the yellow key to enter move status, then press **OK** to mark channel and use **▲▼** key to move cursor where you want to insert channel. At last, press the INFO key to complete channel movement.

- Edit

Press the blue key to enter edit mode.

1、 Sort

Press the red key to list sort type. It includes Name(A-Z), Name(Z-A), Free/Scramble, Lock, Default, Tp up and Tp down.

2、 Edit

Press the green key to enter edit status, and press **OK** to start renaming channel.

3、 Del

Press the blue key to enter delete status, and press **OK** to mark channel you want to delete it.



3.6.2 RADIO CHANNEL LIST

Please refer to **3.7.1 TV Channel List**.

3.6.3 SATELLITE LIST

All the satellite will be displayed on the screen. And press the F1 key to switch to transponder list of the current satellite.



Press the red key to add a new satellite.



Press the green key to edit current satellite.



Press the yellow key to delete current satellite.



Press the blue key to scan current satellite.

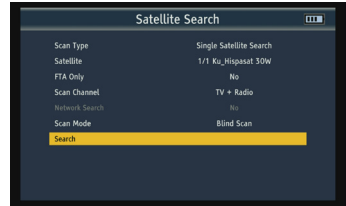

3.6.4 TRANSPONDER LIST

All the transponders under the current satellite will be displayed on the screen, and press the F1 key to show satellite list.



Press the red key to add a new transponder.



Press the green key to edit current transponder.

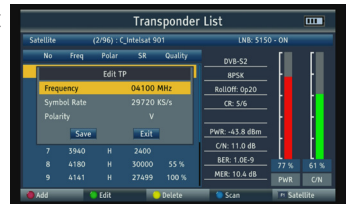

Press the yellow key to delete current transponder.



Press the blue key to scan current transponder.

3.6.5 MOTOR SETUP

There are 5 modes in motor setting:

- USALS
- DiSEqC 1.2
- East Limit
- West Limit
- Disable Limit

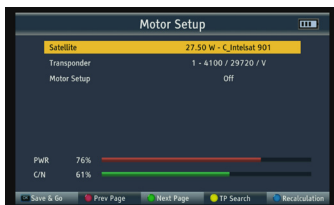

Press the red key to turn to the previous page.

Press the green key to turn to the next page.

Press the yellow key to start TP searching.

Press the blue key to recalculate motor.

3.6.6 SCAN MODE

- FTA Only: Free-to-air mode or not.
- Scan Channel: TV+Radio, TV Channel and Radio Channel optional.
- Network Search: Only use in Full Scan mode.
- Auto Search: Blind Scan and Full Scan optional.

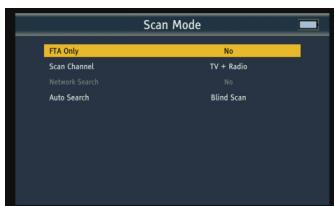

3.6.7 LOOP SEARCH

We can see 1 country/satellite and 8 channels when we enter into this interface, and press ◀▶ key to change them.

There are 3 modes we can choose: DVB-S2, DVB-T2 and DVB-C, and press the yellow key to change it.

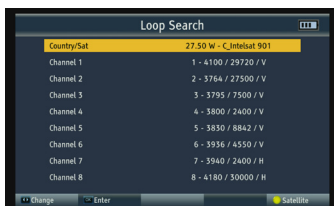

Press **OK** to start loop searching, and signal strength and quality of each channel will be displayed on the screen.



3.6.8 ANGLE CALCULATION

Input satellite longitude, local longitude and latitude by number keys, and the product will calculate the polarization angle, azimuth and elevation on the top of the screen. Press the red key to calibrate.



3.6.9 OPTICAL POWER

Please connect optical port, then we can test the optical power by selecting the wave length and PWR unit. The test result will display in the middle of the screen.

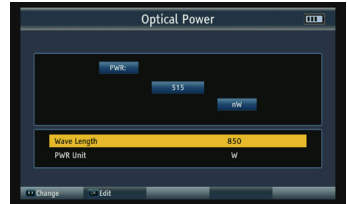

3.6.10 MULTIMEDIA

Before entering the Media Center interface, you need to insert the USB into the USB port.



- Music/Picture/Movie
- Select a file and press **OK** to play it.

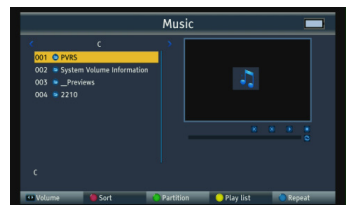

- Record Manager
Press the red key to rename file.
Press the green key to partition file.
Press the yellow key to lock file.
Press the blue key to delete file.



- Ts Record
Press the Start button to record TS file after the signal is locked.



3.7 SYSTEM SETTING



- Language
Press ◀▶ key to change the OSD language, default is English.
- Country
Press ◀▶ key to change the country.
- TV System
Press ◀▶ key to change TV system including PAL/NTSC/Auto.
- Video Resolution
Press ◀▶ key to change the video output resolution including 576i/576p/720p/1080i/1080p/Auto.
- Aspect Mode
Press ◀▶ key to change the aspect ratio including 4:3 LetterBox/4:3 PanScan/16:9/Auto.
- GMT Offset
Press ◀▶ key to change the Greenwich Mean Time offset.
- Beep Tone
Press ◀▶ key to switch beep tone on/off.

- Torch

Press ◀▶ key to switch torch on/off.

- PWR Unit

Press ◀▶ key to change the PWR unit: dBm/dBuV/dBmV.

- Back LED

Press ◀▶ key to switch keyboard LED on/off.

- KeyTone

Press ◀▶ key to switch keytone on/off.

- Speaker

Press ◀▶ key to switch speaker on/off.

- 12V

Press ◀▶ key to switch DC 12V output on/off.

- Parental Lock

1、 Age Limit: Lock All, View All, 7 years, 12 years , 15 years and 18 years optional.

2、 Menu Lock: Press ◀▶ key to switch menu lock on/off.

3、 Channel Lock: Press ◀▶ key to switch channel lock on/off.

4、 New Password: Set new password.

5、 Confirm Password: Set confirm password.

- Factory Setting

Press **OK** to start factory reset.

NOTE: if you set factory setting, all the user settings and the database will be reset.

- USB Upgrade

Before entering the USB Upgrade interface, you need to insert the USB into the USB port.

Press ◀▶ key to change Upgrade Mode including All Code, Maincode and User DB.

Select an upgrade file, then press the Start button to upgrade.

Select an upgrade file, then press the Start button to upgrade.

Warning: Please don't turn power off or pull out the USB, otherwise it will damage the machine's software, and can't boot again.

- USB Backup

There are two backup mode: User DB and Preset. Press the Start button to backup.

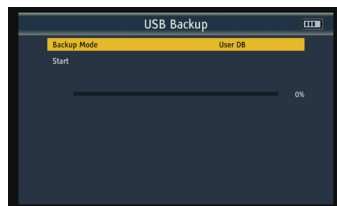
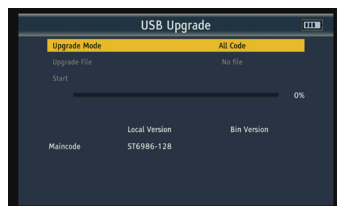
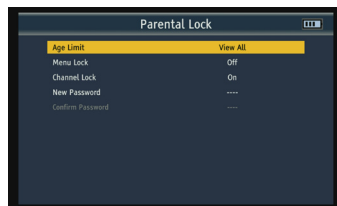

- Information

Press the INFO key to see information about MAINCODE.

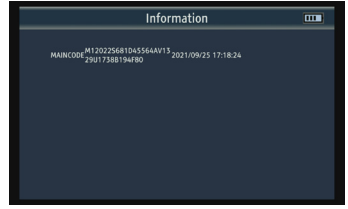

4. TECHNICAL SPECIFICATION

TRANSMISSION STANDARDS	
DVB-S2/S, DVBT/T2, DVB-C	
SATELLITE INPUT/DEMODULATION	
Connector Type	F Type
Input Frequency	950 to 2150 MHz
Signal Input Level	- 65 to -25 dBm
Band Switch Control	22KHz
LNB Supply	13V/18V, IMax 400mA
Demodulation Type	QPSK,8PSK,16APSK
Symbol Rate	2<Rs<45Mband(SCPC/MCPC)
DVB-T/T2/C INPUT/DEMODULATION	
Connector Type	Female Type
Input Frequency	48 to 862 MHz
Signal Input Level	-79.5dBm (MAX)
ANT Supply	5V, 12V/24V Imax 100mA
Demodulation Type	QPSK,16QAM.64QAM,256QAM
LCD FEATURES	
LCD Type	TFT Transmissive
Number of Dots	800 x 3(RGB) x 480
Active area (WxH)	154.08 x 85.92 mm ²
AV output interface	
Connector Type	3.5 mm jack
Video Output	CVBS
Audio Output	Stereo Audio L/R output
HDMI output connector	
Format	HDMI 1.3a
AV input interface	
Connector Type	3.5 mm jack
Video Input	CVBS
Audio Input	Stereo Audio L/R input
AUDIO/VIDEO PROCESSING	
Video decompression	MPEG-2 MP@HL, MPEG-1 Decoding,MPEG-4 ASP@L5 HD resolution,H.264 MP&HP@L4,HW JPEG decoding, HEVC/H.265(10 Bit)

Resolving rate	PAL-25 frame@720*576,NTSC-30 frame@720*480
Signal compatibility	Support conversion for different video formats
Video Format	4:3,16:9,By Pan & Scan and Letter Box conversion
Audio Decompression	MPEG-1 Layer I/II, MPEG-2 Layer I/II
Audio Output Mode	Stereo, Mono,R/L
DATA SERVICE PORT	
Connector	USB
Data Protocol	USB2.0 interface
File Management System	NTFS,FAT32,FAT16
File Format	wma,mp3,mp4,avi,jpg,jpeg,bmp,img
POWER SUPPLY	
Li-Ion Battery	7.4V/5000mAh(The machine behind labeling shall prevail)
Adapter	OUTPUT :DC12V/1.5A, INTUPT :100~240VAC 50/60Hz(Will be subject to actual configuration)
Power Consumption	Max. 10W
PHYSICAL CHARACERSTICS	
Size (W x D x H)	25 x 15.6 x 4 (cm ³)
Net Weight	1kg

5. TROUBLE SHOOTING

Problem	Possible Causes	What To Do
No display light up	Power switch is not on Run out of batteries	Check to make sure power on. Even on adapter
No sound or picture, but the front panel power light is ON.	AV IN jack insert, but no video input	Pull out AV IN cable
No sound or picture	The satellite dish is not pointing at the satellite.	Adjust the dish. Check the Signal Level in the Antenna Setup Menu
Bad picture/Blocking Error	No signal or weak signal	Check the cable connections. LNB and other equipment connected between the LNB and the meter and adjust the dish.
	The satellite dish in not pointing at the satellite	Adjust the dish.
	Signal is too strong	Connect a signal attenuator to the LNB input
	Satellite dish is too small	Change to a larger dish
	LNB noise factor too high	Change to an LNB with lower noise factor
	The LNB is faulty	Change the LNB
AV out No picture(Video)	The system is connected by SCART cable and TV is not in AV mode.	Check the UHF channel fixed in your system and tune the UHF properly.
The key is not working	Out of battery	Even on adapter
	Key blocks	make sure no blocks between the front panel

USER'S MANUAL